

PCM 150/75 G



Sample image

Order symbol : PCM 150/75 G

Product nr : 6016314

UL Code : 6416314

UL Name : UL PCM 150/75 G

Description : Enclosure, PC, metric knock-outs

Remarks : Grey cover

Including : Base with TPE gasket. screws for mounting plate/DIN-rail and cover with polyamide cover screws.

EAN : 6418074038081

El. number :

- Finland : 3421641
- Denmark : 8212027161
- Sweden : 2535327

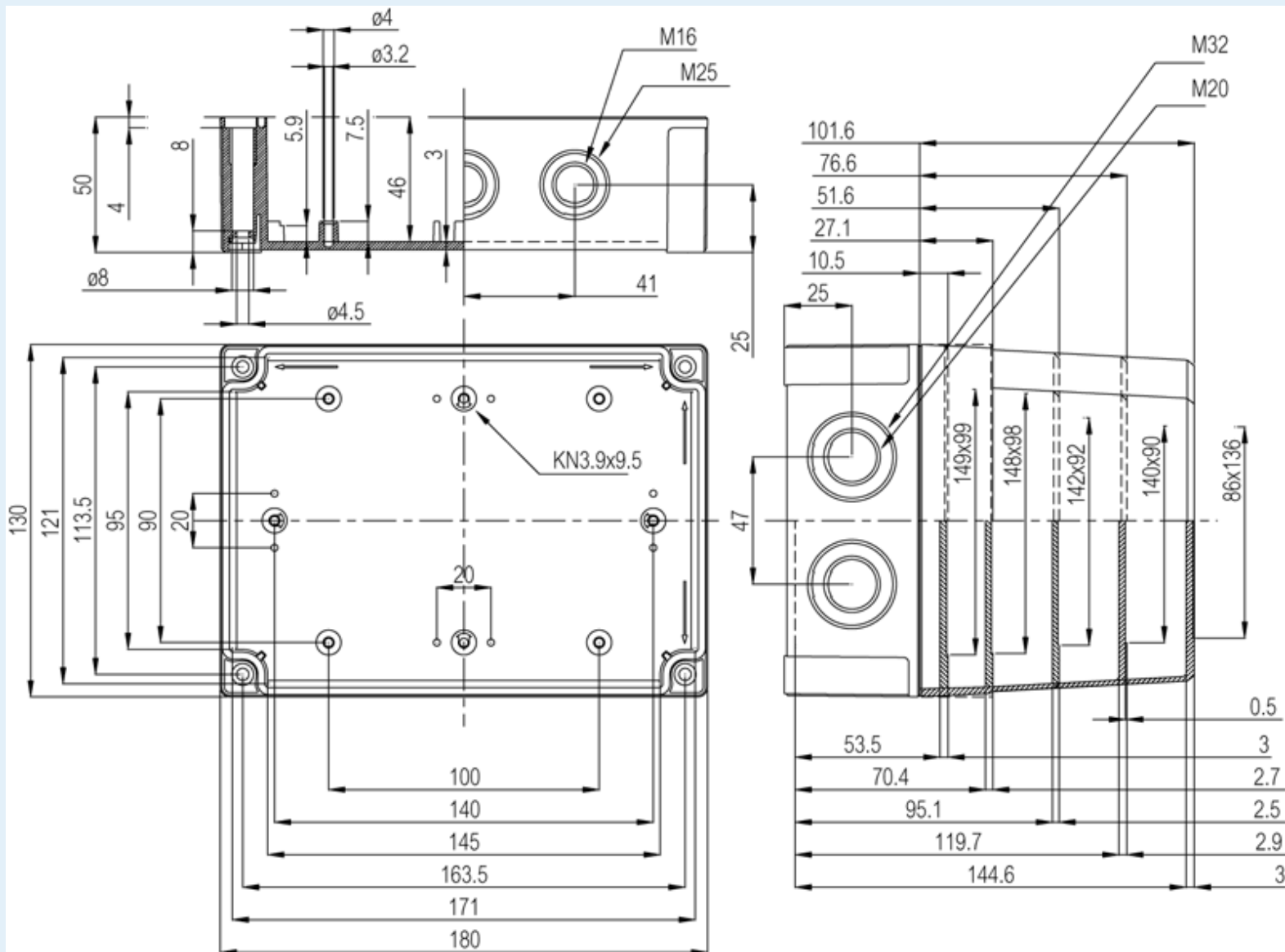

Dimensions :	Height	Width	Depth
mm :	180	130	75
inch :	7.09	5.12	2.95

Materials :

Material :	Polycarbonate
Base colour :	RAL 7035 -light grey
Cover colour :	RAL 7035 -light grey
Gasket material :	Polyurethane

Temperatures :

Temperature °C (short term) :	-40 ... 120
Temperature °C (continuous) :	-40 ... 80
Temperature °F (short term) :	-40 ... 250
Temperature °F (continuous) :	-40 ... 175

Accessories :

MIV 10	DIN-35 Mounting rail, for enclosures: (100 x 35 x 1)
FP A 150/ 180	Front plate (Aluminium), for enclosures: (170 x 112 x 1)
HFP 180	Front plate hinge series
MIV 150	Mounting plate (Galvanized steel), for enclosures: (148 x 98 x 1)
MIN 15	DIN-15 Mounting rail, for enclosures: (150 x 15 x 1)
MIN 10	DIN-15 Mounting rail, for enclosures: (100 x 15 x 1)
MIV 15	DIN-35 Mounting rail, for enclosures: (150 x 35 x 1)
FP 22046	Wall fastening lug (4 pcs)

Rating :

Ingress protection (EN 60529):	IP66; IP67;
Impact Resistance (EN 62262):	IK08;
Electrical insulation :	Totally insulated

Halogen free (DIN/VDE 0472, Part 815):	1
UV resistance :	UL 508
Flammability Rating :	UL 746C 5"
Glow Wire Test (IEC 695-2-1) °C :	960 °C
NEMA Class	

Certificates :

Certificate FI 40847